



LONESTAR
FIBERGLASS POOLS



Jump
into fun!

LoneStarFiberglassPools.com



LoneStar Fiberglass Pools

specializes in manufacturing and installing fiberglass swimming pools and spas all across the U.S. We stand behind our products, offering Lifetime Warranties on each fiberglass pool that we manufacture.

We work diligently on recruiting and training the most highly skilled dealers from across the country. We offer 26 different pool and spa models to choose from in 7 different color options.

LoneStar offers turnkey sales within 100 miles of our factory located in New Braunfels, Texas. Follow the U.S. buying trend: buy direct from the manufacturer and save!

Our mission at LoneStar Fiberglass Pools is to provide you with the highest quality pools, products, and services using the most state-of-the-art technology while keeping our prices affordable!

Thank you

for your interest in LoneStar Fiberglass Pools. The owner, Chris Owens, started out in the fiberglass pool industry over 20 years ago. He worked for a large national fiberglass pool company, delivering and installing hundreds of fiberglass pools. Chris quickly moved into manufacturing and then was promoted to General Manager of the company. In 2007 he acquired the assets of the company and started LoneStar Fiberglass Pools.

In the decade plus that Chris has owned LoneStar Fiberglass pools, he and his team have grown the business by expanding the turnkey installation services, as well as expanding the dealer network across the United States. The goal of LoneStar Fiberglass Pools is continued expansion and to enjoy life with our team, customers, dealers and friends.

“As the owner of LoneStar Fiberglass pools, I’m grateful to serve our customers and dealer network. My team and I wish you all the best and look forward to hearing all the great pool party stories.”

Sincerely,

Chris Owens



**LIFETIME
WARRANTY**



**26 POOL &
SPA MODELS**



**7 COLOR
OPTIONS**



**LAZY RIVER
OPTIONS**

Why should I consider buying a fiberglass pool?

Fiberglass pools are not only beautiful, they are affordable, quick to install, and easy to maintain. Plus, they provide a lifetime of fun and enjoyment.

How long does it take to install?

It depends on the season. During cold weather months, you could have a pool installed in a few days. In the summer months, with higher demand, it may take longer. That’s why it’s important to contact us now if you are considering buying a pool.

How will a swimming pool affect the value of my home?

A pool will certainly increase your home’s value. The biggest value is simply the fun and enjoyment a pool provides you and your family.....and that’s priceless.

LoneStarFiberglassPools.com



Why fiberglass?

Are you looking for a swimming pool that's:

Affordable, quick to install, easy to maintain, and will provide a lifetime of enjoyment? That's what you'll get with a LoneStar Pool!

If you are a first time pool buyer,

we'll guide you step by step through the buying process and help you avoid the most common mistakes when buying a new pool.

If you have owned a pool before,

you already know the advantages of a fiberglass pool. Turn to page 11 and check out our fiberglass pool selections. Contact us for a quick, free, in-home no obligation quote.

If you're a do-it-yourselfer,

let our installation specialist help you select which DIY package is right for you.

Want to see how your LoneStar pool is built?

Contact your local manufacturer and set up an appointment with a direct sales person.

No Renovations

Fiberglass pool owners enjoy peace of mind knowing their pool will last forever! Gunitite or vinyl liner pool owners have their monthly pool payment, higher electrical bills, higher chemical bills and must save up their cash or use their credit card for renovations and re-linings about every 7-10 years.

Typical Gunitite Pool Plaster Resurfacing: \$5,500

A properly maintained surface of a gunitite pool has a life expectancy of 7-10 years. However, with each acid wash, a layer of plaster is etched away, making the need for resurfacing a big expense.

Typical Vinyl Liner Replacement: \$3,700

Well maintained vinyl liners may need to be replaced every 4 years. Adverse pH conditions and strong ultraviolet light rapidly deteriorate vinyl liners, reducing their life span drastically.

Fiberglass Resurfacing: \$0

Fiberglass pool owners never pay for renovations as long as pool chemistry is properly maintained.

“Choosing a fiberglass pool won’t break your budget!”

Fewer chemicals

The pH value in a fiberglass pool is more stable because there’s not a chemical reaction occurring between the surface and the water. Acid is rarely (if ever) used, so chlorine demand is significantly less. A fiberglass pool typically uses about 70% less chemicals each month! Algae can only grow on the surface of the fiberglass pool and is simply wiped off and circulated away.

In a gunitite pool, a chemical reaction occurs between the plaster and the water, causing alkalinity from the plaster surface to leach out into the water. This reaction constantly raises the pH value. Acid or soda ash, plus additional chlorine are used to combat the constant change. Algae that grows from within the pores of the plaster must be removed with muriatic acid. At a cost of \$60-\$100 per month, pool service companies make a good living maintaining gunitite pools.

Fiberglass pool owners find caring for their pool is easy and love the idea they NEVER need to pay \$60-\$100 per month for pool service! Water chemistry is intimidating enough without the pool surface compounding the problem. A fiberglass pool is easier to maintain no degree required!

Lower electric bills

Gunitite pools require 8-12 hours of circulation per day. Dirt hides in pores of plaster, so frequent brushing and vacuuming is required. As the pool gets older and rougher and the plaster surface ages, the circulation time increases! The smooth satin surface of a fiberglass pool has ageless beauty.

Fiberglass pools circulate in just a few hours each day. The satin smooth surface of a fiberglass pool offers little resistance to water movement. Water moves quickly and circulates with fewer hours of pump operation. With no pores in which dirt can settle, fiberglass pools look and stay cleaner too.

Higher electrical costs are rarely calculated into the overall price of a pool, but they should be! You may already cringe when the electric bill arrives each month; Add the electrical demand of a pool pump to your bill and it can either make or break your pool budget. Choosing a fiberglass pool won’t break your budget!

“Fiberglass Pool owners enjoy peace of mind knowing their pool will last forever!”

Facts & Myths

Here are some facts on the most common misunderstandings about fiberglass pools.

Fact

Fiberglass pools last forever

Imagine throwing away a fiberglass boat. No way! Quality boats don't ever wear out. Provided it is moderately maintained, a quality fiberglass pool will last forever, looking very much like the day it was installed! Once nestled properly in the ground, they will remain beautiful and functional forever! We use some of the same resin and materials used to build underground fiberglass gasoline storage tanks at gas stations around the world. This fact alone confirms just how strong fiberglass products are.

Myth

Fiberglass pools don't look like a real pool

We always snicker at this one because fiberglass pools are real pools. In fact, a fiberglass pool that has been installed with a cantilevered deck and perhaps optional waterline tile is impossible to distinguish from a brand new plaster pool. To tell the difference, one must reach in the water and touch the satin smooth surface. The big difference is that the fiberglass pool will retain its good looks, whereas a plaster pool will begin to look pitted, rusted, and blotchy after just a few short years.

Myth

Fiberglass pools "pop" out of the ground

This statement is a common scare tactic that the vinyl and gunite industry uses to deter potential clients away from fiberglass pools. The gunite industry loses all credibility after the customer gets the facts. Lots of people ask this question, and we, as manufacturers, are happy to set the record straight!

Any watertight vessel (in this case, your pool) will float, regardless of what it is made of, provided the vessel is empty and there is water under it. This same "principle of displacement" is what allows heavy concrete barges to float as easily as lightweight fiberglass boats. What overcomes displacement? The weight of the water! This is why boats that have sunk do not "pop" out of the water!

The reasons to drain a pool in the first place (resurfacing, acid washing to remove algae, or draining to correct a severe out-of-balance chemical situation), don't apply to fiberglass pools. So, it is rare to ever need to completely drain a fiberglass pool. However, vinyl and gunite pools do require draining for major maintenance and renovation. The truth is that the majority of the pools that become dislodged (float or pop) are actually gunite or vinyl liner pools.

Fact/Myth

Fiberglass pools are cheaper

The answer is, truthfully: yes and no. In many areas of the country, the purchase price of a fiberglass pool is about the same or slightly more than an equivalent gunite pool. A fiberglass pool is more expensive than a vinyl liner pool, and should be! The materials are more expensive, but fiberglass last forever! Any uninformed buyer may mistakenly assume fiberglass pools fall in the temporary, above-ground price range, which is not true. Fiberglass savings are realized monthly in electrical and chemical costs. The higher expenses of a vinyl or gunite pool add up quickly. In areas where fiberglass pools initially cost more, the difference is quickly made up after a few years of paying these bills.

Our Facts

- ✓ We offer a **lifetime** warranty.
- ✓ Our pools are built in a state-of-the-art factory with strict **quality control conditions**.
- ✓ Our pools feature **smooth non-porous** walls that reduce the growth of algae.
- ✓ Our smooth surface makes cleaning much easier, **reducing maintenance by as much as 90%** compared to a concrete pool.
- ✓ Fiberglass is **17 times stronger** than concrete and can sustain 12" of flexing movement ...this would destroy a concrete pool.
- ✓ Installation is **quick**, and causes minimum disruption to your home.



Couldn't be happier with our pool! Everyone at LoneStar was great from start to finish. The finished product is even better than we expected. Thanks to you all.

- Trey W.



My LoneStar Fiberglass pool is awesome and admired by many family and friends. The design, smooth texture, and color option is mesmerizing. Low maintenance and never scraping the bottom of your feet like concrete pools do. Owner and team are all extremely humble and honest. I don't say that very often and they care about your investment.

- Anthony J.



The best company to buy a pool from. They had my pool installed in a week. Great people. Great service. Thank you for all the hard work. We will have years of fun.

- Donna K.

Pool Comparison

Pool Type	LoneStar Fiberglass Pools	Gunite Pools	Vinyl Liner Pools
Warranty	Lifetime	Sometimes 1 Year	Seam Only Warranty
Surface Type	Silky Smooth	Rough	Smooth
Surface Quality Control	By Factory	By Installer	By Installer
Average Installation Time	5-7 Days	6-8 Weeks	2-3 Weeks
Weekly Maintenance Hours	1 Hour	8 Hours	3 Hours
Painting	Never	Yearly	Never
Steps	Built In	Built In	Optional
Relocation Possible	Yes	No	Yes
Drainage of Pool	Never	Yearly	4+
Common Concerns	None	Expensive to Build & Maintain	Liners Stretch & Puncture

Our Process

Step **1** Gelcoat/Shimmering Finish UV stabilized

Step **2** Chopped Gun Roving Fiberglass with 100% Vinyl Ester Resin

Step **3** Chopped Gun roving Fiberglass with 100% Isothalic Resin

Step **4** Hand Laid 36oz. Woven Roven

Step **5** Chopped Gun roving Fiberglass with 100% Isothalic Resin

Our Colors

**Colors may vary slightly*

Caribbean Blue

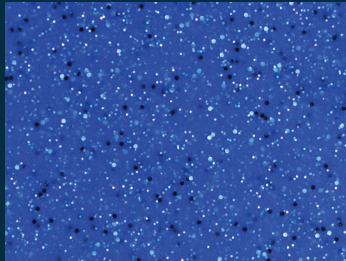

Fiji Blue

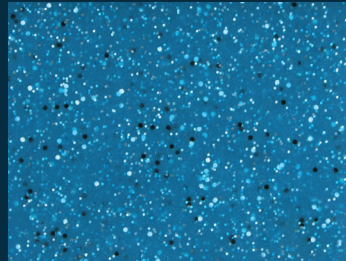

Desert Sand



Sky Blue



Pacific Blue

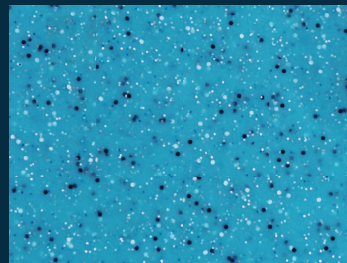

Sapphire Grey

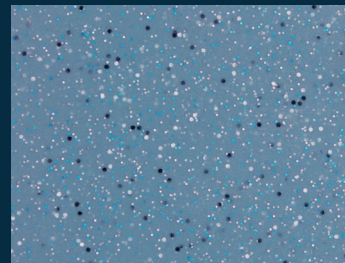

Arctic White

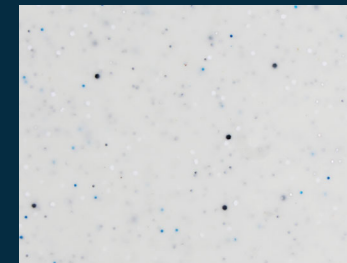

Step
7

Chopped Gun roving
Fiberglass with 100%
Isothalic Resin

Step
9

Chopped Gun roving
Fiberglass with 100%
Isothalic Resin

Step
6

Hand Laid 36oz.
Woven Roven

Step
8

Hand laid 36oz.
Woven roven

Step
10

Hand Laid 36oz.
Woven Roven



Build yours

Spas

Spas combine the therapeutic benefits of a hot tub with the functionality of a traditional pool! With relaxing jets and temperature-controlled water, owners can enjoy their spas year round.



The Boston
37' Deep Round
Spillover Spa

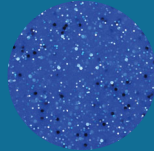
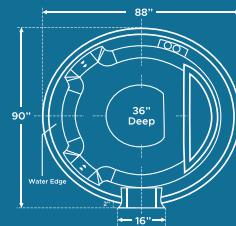

The Portland
36' Deep Octagon
Spillover Spa

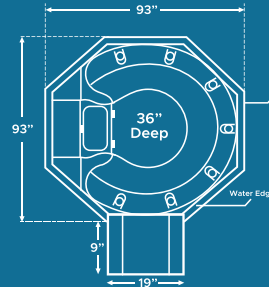

The Flagstaff
36' Deep Octagon

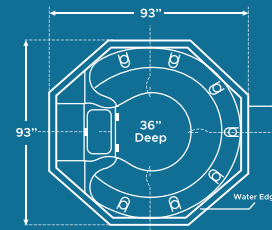

The Dallas
44" Deep Rectangular Spa

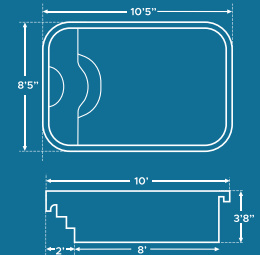

The Serenity
Tanning Ledge

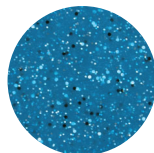
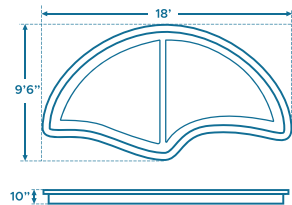

The Arlington
Tanning Ledge

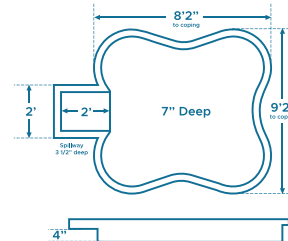

The Tahoe
Tanning Ledge

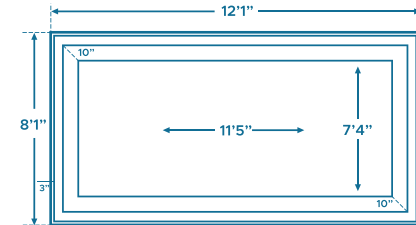

Small Pools

While conventional inground pools typically require larger installation sites, a small fiberglass swimming pool can fit in even the coziest of properties. By working with our sales rep that specializes in fiberglass pools, you can choose the right design for your needs.



The **Cheyenne**

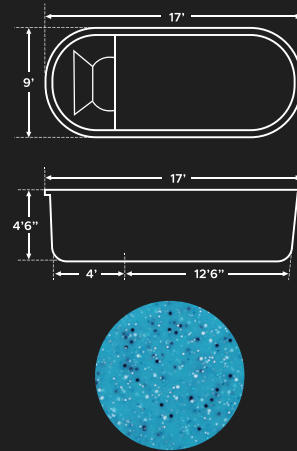

The **Lincoln**

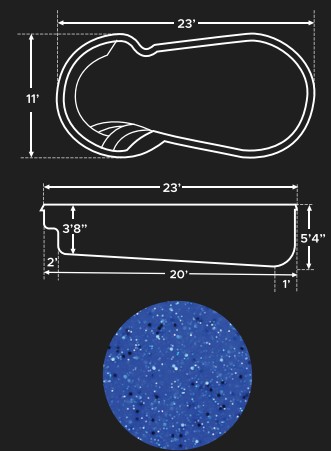

The **Denver**

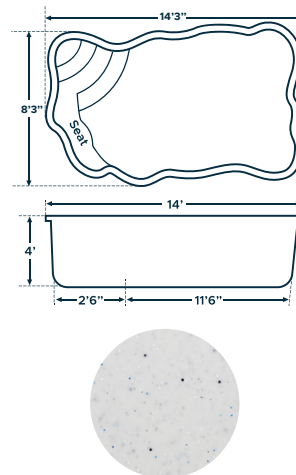

The **Memphis**

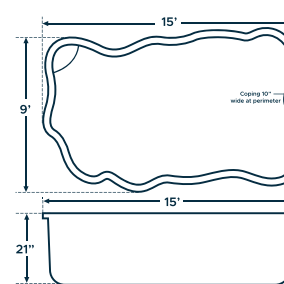

The **Miami**

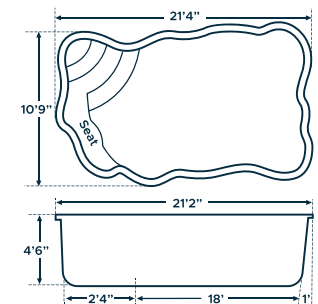



The **Kingsbury**

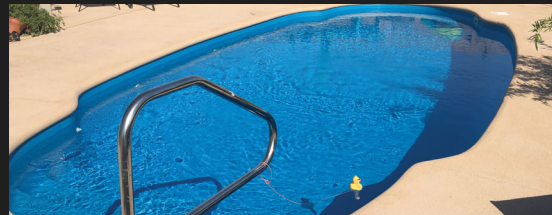
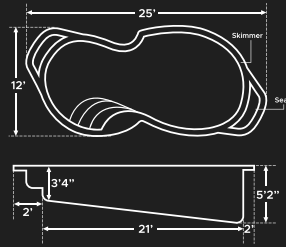

The **El Dorado**

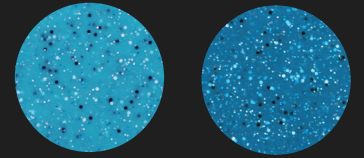
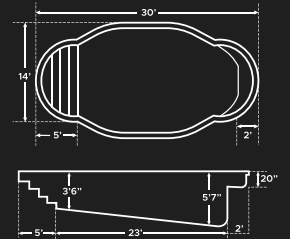

The **Atlantis**

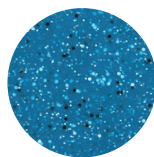
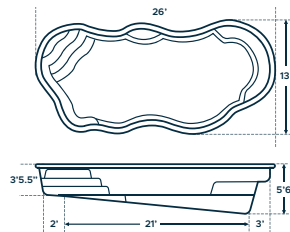

The **New Orleans**

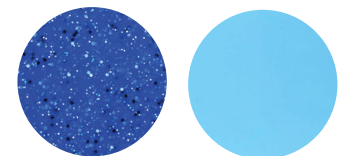
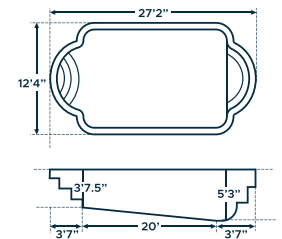

Medium Pools

With a medium sized pool, you can easily turn your yard into a place of quiet relaxation that provides endless hours of summer fun. After deciding which pool to put in your yard, your next fun challenge will be deciding which pool end to jump in first.

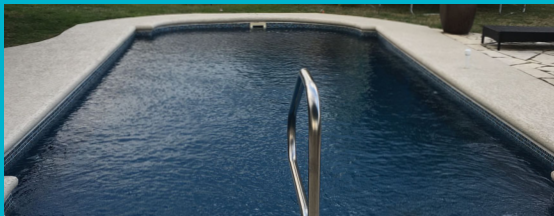
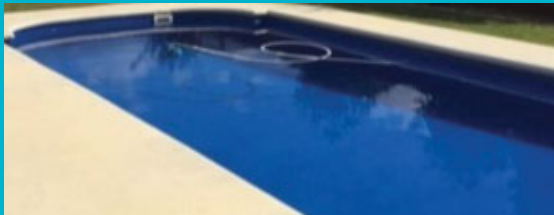

The **Phoenix**

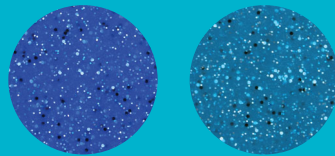
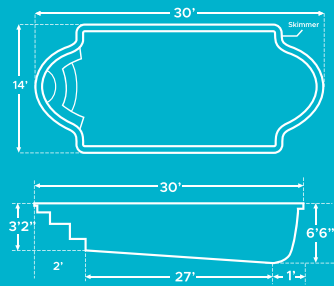

The **Cabo**

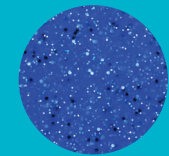
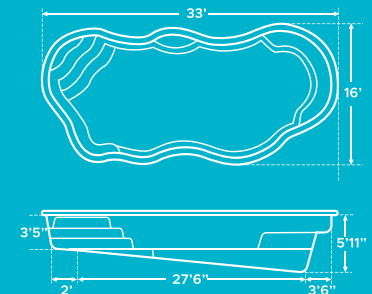

The **Santa Fe**

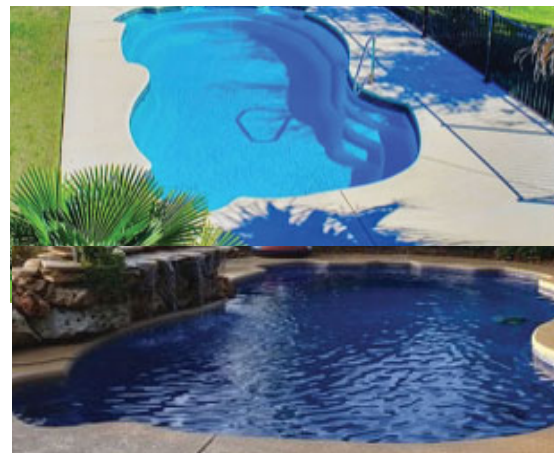
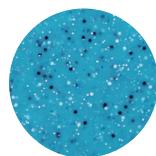
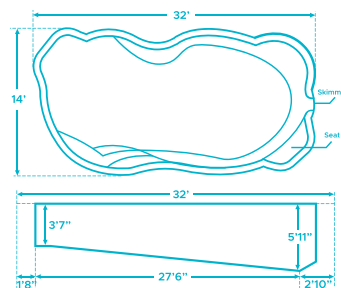

The **Savannah**

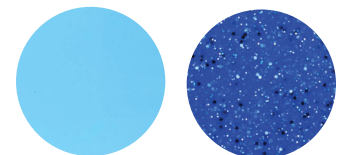
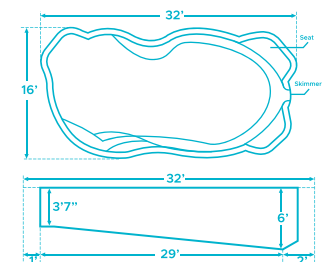

Large Pools

With a large pool, you can truly soak up the sun and enjoy the summer with your own backyard oasis. We have several large pool options that have multiple seating areas. Want to have your own backyard oasis? Contact a LoneStar Fiberglass Pools sales representative today!

The Vegas

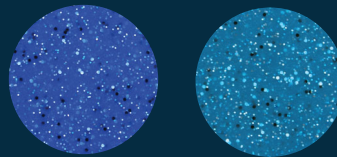
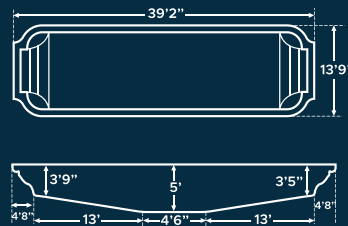

The Independence

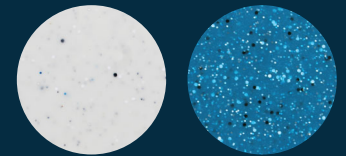
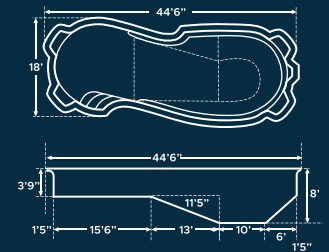

The Charleston

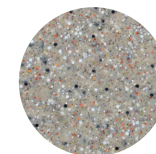
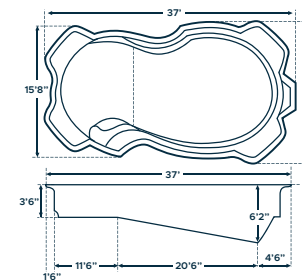

The Tulsa

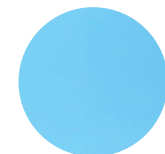
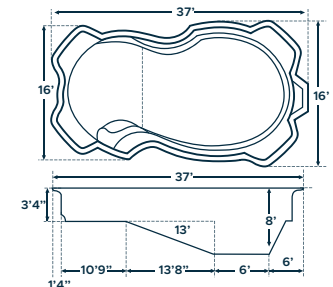

Our new models

The Laguna

33'4" x 15'6"

Our Laguna is great for basking in the sun to achieve a perfect tan while also keeping you cool and fresh. This pool makes an easy transition from tanning to swimming in just a few steps.

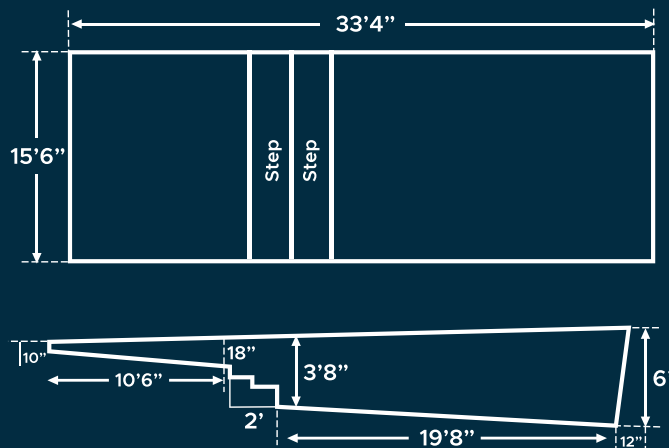

With your new pool

It is important to have your excavator review the Dig Diagram prior to excavation. All dimensions are approximate. A 4" over-dig must be added to the bottom for the stone, along with a 1' by 2' trench from the pool hole to the area of the equipment placement for plumbing and wiring.

The Malibu

33'4" x 12'6"

The Malibu is a modern look with smooth edges perfect for tanning in our shallow design, with a sleek beach entrance into a comfortable depth for swimming and treading. Beautiful resort chairs are also available for purchase.

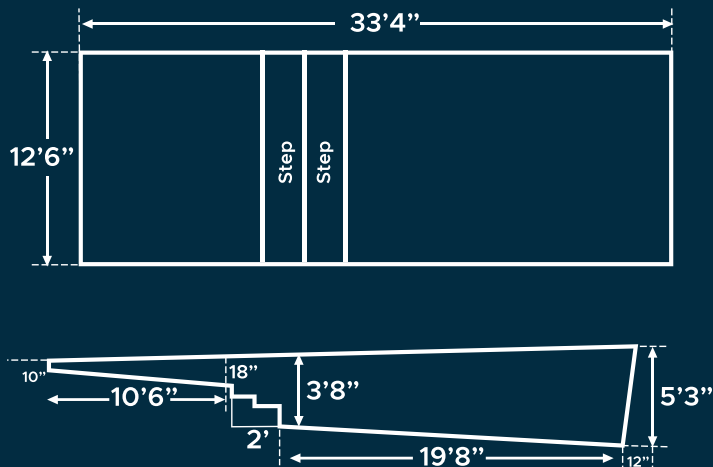

Our Installation

1

Excavating
the hole...



2

Preparing
the hole...



3

Delivery
of pool...



4

Setting
the pool...

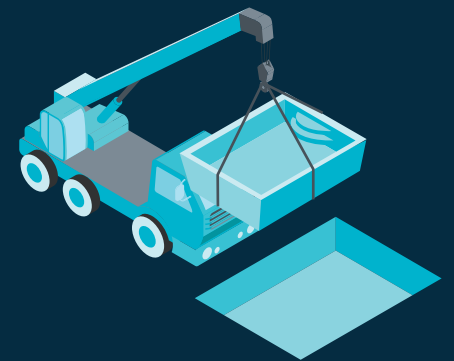

5

**Backfilling
the pool...**

(With 3/8 Crushed Limestone)

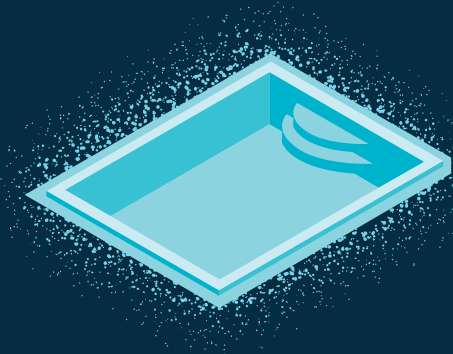

6

**Concrete
prep...**

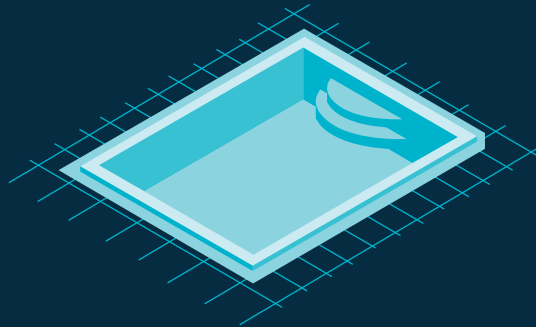

7

**Completed
& ready to jump in!**



Benefits of swimming

Weight loss

Swimming is a great way to burn calories. And the more calories you burn, the more fat gets mobilized. As a result, you will start losing the extra flab in your body. Korean scientists conducted an experiment on obese children and found that swimming and other aquatic exercises helped reduce fat mass in their body.

Bone strength

Bone mass decreases with age, especially in women. Swimming can help prevent bone loss triggered by age and other forms of aerobic exercises. It is also helpful for those with joint pain or arthritis. Scientists conducted an experiment and found that swimming ameliorates osteoporosis, helps improve bone mass, and strengthens the bones.

Improves heart health

The number of people suffering from heart diseases has skyrocketed in the recent past. So, if you lead a sedentary lifestyle and feel that going to the gym is dreadful, try having fun in the cool blue water. This aerobic exercise will help improve your heart health and protect you from potential cardiovascular diseases. In fact, various studies have found that swimming is one of the best exercises for keeping your heart in good condition.

Improves flexibility

Flexibility is the ability to move your joints to their full range. When you swim, you use your limbs and core to propel your body forward and stay afloat. Swimming every day helps improve whole body flexibility and, as a result, reduces joint pain.

Improves body coordination

It's a no-brainer that swimming requires a lot of coordination between the legs, arms, head, chest, and eyes. Be it for recreational, therapeutic, or competition purpose, swimming helps improve your whole body movement and coordination between the limbs and the core.

Improves sleep quality

If you have difficulty in sleeping, you must start swimming. Swimming is a full-body aerobic exercise, and if you have ever spent some time in the water, you know how exhausting it can be. That's because your entire body, along with your brain, works constantly while swimming. This is precisely why you will start to sleep better.

Supports mental health

Stress, anxiety, and depression are mental health issues that you should never ignore. Scientists have found that swimming can help uplift mood and treat various serious psychological issues.

Swim strokes



The **freestyle**

is swam in a horizontal position with the body facing down. The body rolls from one side to the other, always turning to the side of the arm that is currently pulling in the water. The head remains in a neutral position, face down, except when breathing.



The **backstroke**

uses alternating and opposite arm movements. As one arm pulls through the water from an overhead position to the hip, the other arm recovers above the water from the hip to the overhead position and vice versa. The legs perform a flutter kick, similar to the one used in freestyle.



The **butterfly**

Extend your arms above your head. Pull hands toward your body in a semicircle, with palms outward. Push your palms backward. Pull your arms along your sides and past your hips.... Recover. Finish the pull by dragging thumbs on your thighs as you finish the stroke.



Treading **water**

To scull water, raise your arms sideways to shoulder height and then move your arms forward and back, pushing against the water with your hands. The pressure your arms and hands exert on the water creates some buoyancy that keeps your body afloat.



Flutter **kick**

Push one leg down in the water by slightly bending the knee and pushing the water down on top of your foot, repeat this motion on your alternate leg. When doing it correctly, the power driven in your hip will naturally move the knee slightly. Do not forget to point and slightly turn inwards your toes to also minimize dragging within the water.



Back **float**

You need to align your body with the water -- ideally, your body should start off in a position that is almost parallel to the water or bottom of the pool. Lift your chin, and make sure the water line is at mid-cheek. Stay centered, lift your chest and arch your back slightly.



Pentair Products

LoneStar Fiberglass Pools
is an Authorized Dealer of
Pentair Pool Products



Authorized Dealer Coverage Area

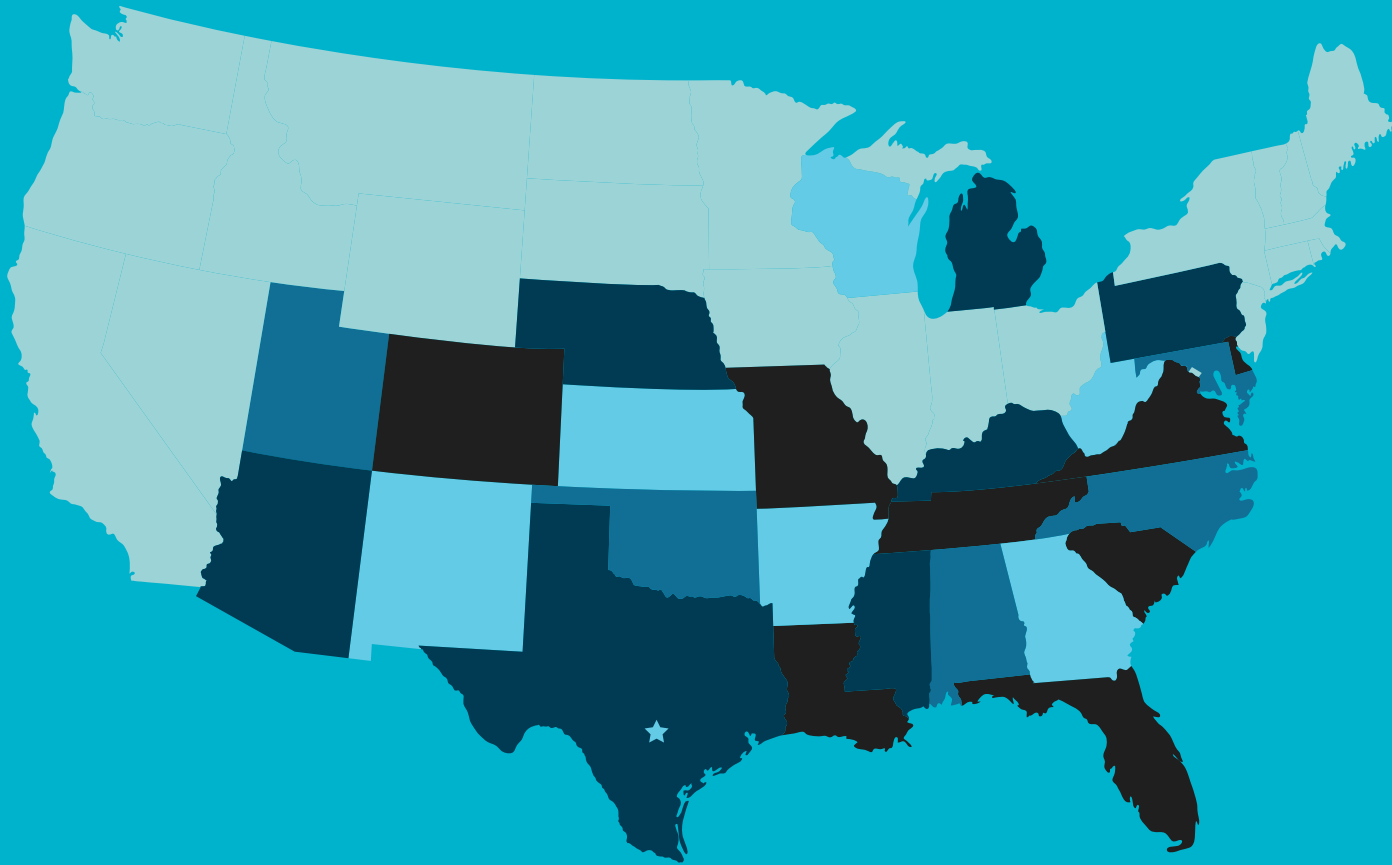

**Manufacturing Facility and
Corporate Office Retail Location:**

7150 N IH-35

New Braunfels, TX 78130

P: (830) 625-SWIM (7946)

info@lsfptx.com

Buy direct from the largest
fiberglass pool manufacturer in
Texas. Visit us today at our local
New Braunfels location.



LONESTAR
FIBERGLASS POOLS

LoneStarFiberglassPools.com



LoneStarFiberglassPools.com



**Manufacturing Facility and
Corporate Office Retail Location:**

7150 N IH-35
New Braunfels, TX 78130
P: (830) 625-SWIM (7946)
info@lsfptx.com



LONESTAR
FIBERGLASS POOLS

Buy direct from the largest
fiberglass pool manufacturer in
Texas. Visit us today at our local
New Braunfels location.